

cotas piscina (exterior)
côtes piscine (extérieure)
Schwimmbadmasse (Äussere)

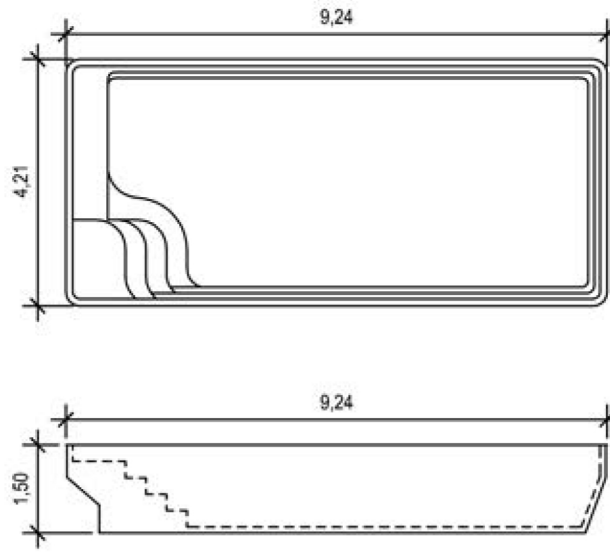

cotas excavación
côtes d'excavation
Aushubmasse

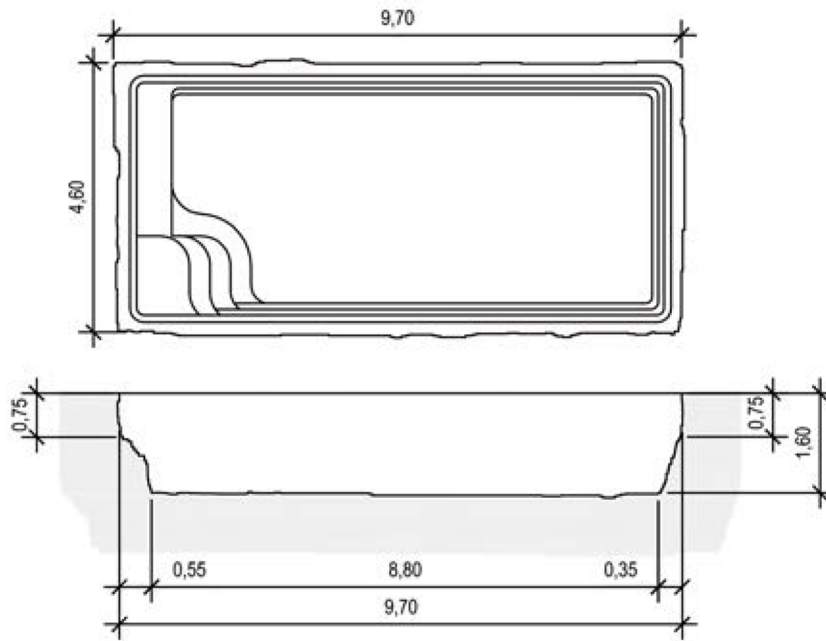

preparación terreno (regla de base)
préparation du terrain (règle de base)
Vorbereitung des Bodens (Faustregel)

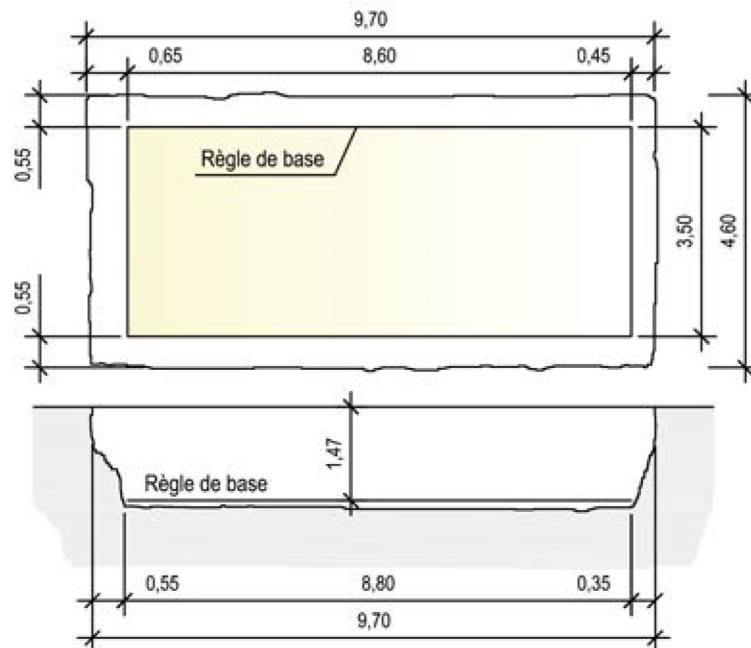

Unique 9